

DT06-6S

标记 MARK	ECN	修改内容 REVISIONS	签名 DWN.	日期 DATE

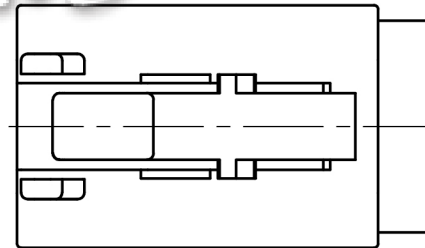
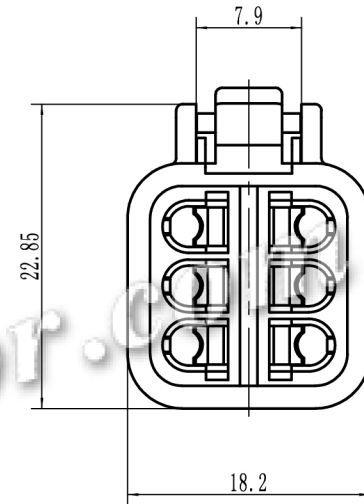
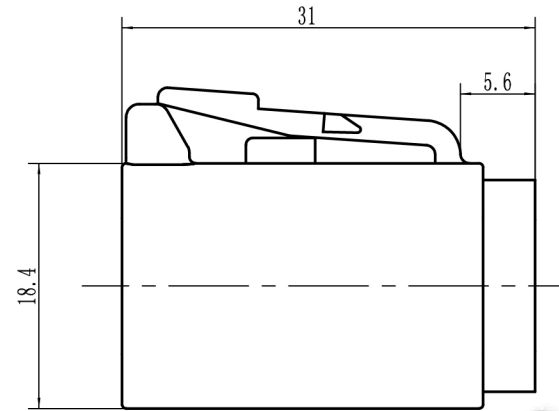
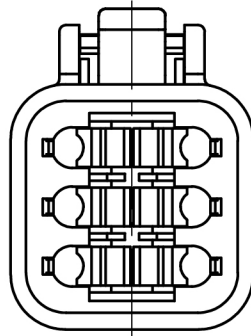

NOTES

1. The sharp Angle is blunt.
2. No tolerance shall conform to the requirements of GB/T14486-2008-MT6.
3. On the machining surface of parts, there should be no scratches, scrapes and other damage parts surface defects.

技术要求

1. 锐角倒钝。
2. 未注公差应符合 GB/14486-2008-MT6。
3. 零件加工表面上, 不应有划痕、擦伤等损伤零件表面的缺陷。

未注尺寸公差表
NO. TOLERANCES GB/14486-2008-MT6

尺寸范围 DIM. RANGE	尺寸公差 DIM. TOLERANCES	尺寸范围 DIM. RANGE	尺寸公差 DIM. TOLERANCES
0~3	±0.23	>14~18	±0.36
>3~6	±0.26	>18~24	±0.40
>6~10	±0.29	>24~30	±0.45
>10~14	±0.33	>30~40	±0.50

镀涂 SURFACE TREATMENT		乐清市千工电器有限公司 YUEQING KINKONG ELECTRIC CO., LTD.				
产品材料 MATERIAL		设计 DARAWN BY		审核 CONFIRMED BY		批准 APPROVED BY
产品名称 NAME	6孔连接器 6-HOLE CONNECTOR	/		/		/
物料编号 PART NO.						
产品型号 TYPE	DT06-6S	版次 REV.	第一视角 1st-PERSON VIEW	比例 FREE	单位 UNIT	页数 PAGE
客户型号 ARTICLE NO.		1.0		2.5:1	mm	1/1
重量 WEIGHT						